

The key to independent living...  
Home paging systems for people who are deaf or deaf-blind and hard of hearing



Clofield Limited

# Silent Alert

## Paging System

Product Data Sheets



## SignWave Portable Receiver

Simple to use and ergonomically designed for both Deaf and Hard of Hearing people, the portable SignWave receiver uses strobe, variable sound frequencies and the incoming alert symbol to notify the user to an event occurring.

Alert Options include:

Door Entry	Doorbell	Telephone
Car Alarm	Baby Alarm	Person to Person
Fire Alarm	Smoke Alarm	Burglar Alarm
Chair Leaving	Door Monitor	Carbon Monoxide
Low Battery	Fall Alarm	Movement Monitor



Each event has a unique sound to help the user identify the different alerts. The volume and frequency settings can be altered to suit the individual's needs.

Once the SignWave is placed in its bedside charger base, an optional vibrating pillow pad will activate to help wake the user if a signal is received during the night.



- Unique sound for each event
- Simple event display
- Ergonomic design making it easy to pick up and dock
- Large cancel button
- Volume control
- Two frequency settings
- Smoke alarm override
- Options to cancel strobe or sound
- Pillow pad option
- Mains failure backup
- Long range option extends the open air range from 100m to approximately 1000m
- Fire Safe compatible
- 1 Year Warranty
- Technical helpline

### Operating Range

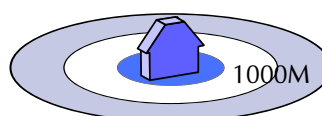

## Pager Unit

### Pager Unit (Yellow)

Lightweight & discreet, this fully portable vibrating Pager unit will alert users to everyday sounds. It can be worn on the belt, in a pocket or around the neck using the cord supplied.

The unit works with both the Alarm Clock and basic charger options providing the user with 24 hour notification from the full range of Silent Alert monitors.



### Alert Options include :

Telephone	Doorbell	Door Entry
Person to Person	Baby Alarm	Car Alarm
Burglar Alarm	Smoke Alarm	Fire Alarm
Carbon Monoxide	Door Monitor	Chair Leaving
Movement Monitor	Fall Alarm	Low battery

The unique Surekey™ feature, together with a different vibration pattern for each event, makes the pager fully accessible to the Deaf/blind user. High colour contrast coupled with Braille, moon or raised text adjacent to each key ensures easy access to this multi event system.



When used in conjunction with the Fire Safe™ and Mini Fire Safe™ systems, the pager enables the user to be notified of the activation of Fire Alarm systems.

- Live Baby Alarm volume display
- Lightweight and discreet
- Clear backlit display with integral symbols
- Unique vibration patterns for each event
- Available in blue or bright yellow
- Integral rechargeable battery
- Last event recall
- Fire Safe compatible
- Monitor low battery alerts
- Surekey™ feature enables cancelation of the active key with a visual reminder.
- Braille, Moon or raised text labelling adjacent to each key available for visually impaired users
- Long range option extends the open air range from 100m to around 1000m
- Technical Helpline
- 1 year warranty



Baby Alarm volume display



## Alarm Clock Charger Charger

Two versions of the charger are available, both are mains powered with battery backup and enable the Pager to be recharged whilst still providing notification to the user of monitored events such as the fire, phone and baby alarm via the vibrating pillow pad.



Both charger options confirm the Pager is correctly docked by giving three shakes of the Vibrating Pillow Pad.

The Alarm Clock Charger has all the functions of the basic Charger with the addition of backlit function keys and a digital alarm clock with snooze function.



- Low profile ergonomic design
- Pillow Pad option
- Mains failure backup
- Digital alarm clock option
- Snooze facility 1 year
- warranty
- Technical Helpline



## Vibrating Pillow Pad (Available separately)



Made in the UK



## Wireless Smoke Alarm (Ionisation, Optical)

### Wireless Heat Alarm

Powered by a single 9V PP3 alkaline battery, these alarms, with integral radio transmitters are suitable for all situations where Deaf and Hard of Hearing people require early warning of an outbreak of fire, whilst providing a powerful audible alarm for those with good hearing.

The units are simply attached to the ceiling with the two screw fixings provided, a test button allows the user to regularly test both the smoke alarm and radio transmitter link in one easy operation.

A choice of Ionisation, Optical or Heat alarms with audible sounder are ideal for all domestic environments.

**Ionisation alarms** respond quickly to fire and should be used upstairs.

**Optical alarms** detect larger smoke particles and can be used downstairs or near to a kitchen and are less susceptible to false alarms.

**Heat detectors** are triggered by a rapid rise in room temperature and are suitable for use in a kitchen or laundry.

With automatic battery monitoring, the alarms also send a signal to the Pager and portable SignWave receiver when the battery needs changing.

By selecting the system override facility, multiple users on different radio channels can be alerted to activation of smoke alarms in common areas such as communal escape routes and stairways.



- Choice of Ionisation, Optical or Heat alarm
- Single 9V alkaline battery
- Test button
- Automatic low battery signals
- 1 year warranty
- Technical Helpline
- Operating range in open air approximately 1000m



Made in the UK





## Universal Monitor

### Universal Monitor with External Microphone

The Universal Monitor is a versatile addition to the Silent Alert range allowing the flexibility to use both audio and external wired connections to trigger the unit (either individually or in combination).

When used as a baby alarm or sound monitor, trigger delays and the sensitivity control are used to find the optimum setting. Visual confirmation of the audio monitoring function can be selected if required and is ideal for user setup.

An external microphone version can be used to monitor door entry phones where it is not possible to make a wired connection. The trigger delay keys can be used to optimise the performance.

Clofield Ltd DO NOT recommended the use of audio monitoring of smoke alarms.

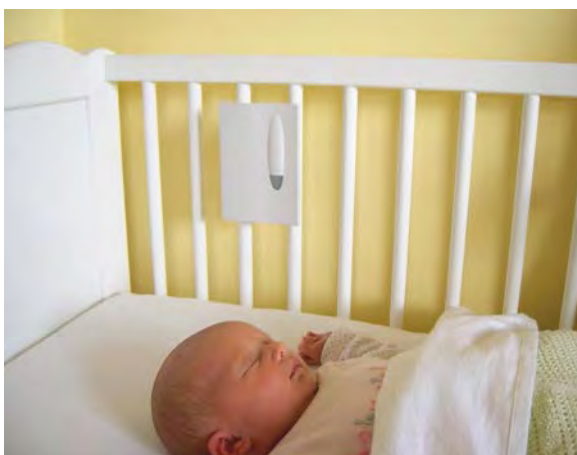

- Volume level indication for Baby Alarms
- Battery or mains power options
- Sensitivity control
- Three trigger delays:- short, medium and long
- Automatic battery voltage indication on start up
- Automatic low battery signal to Pager or SignWave
- Audio monitoring display
- Can be triggered by voltage or a short circuit
- Optional external microphone version
- Can be set to light any symbol on Pager or SignWave
- 1 year warranty
- Technical Helpline
- Operating range in open air approximately 1000m



## Universal Monitor with inline power supply

Designed to link into existing mains powered interlinked smoke detectors and existing door chimes.

These discrete, mains powered transmitters have emergency battery backup which includes automatic low battery monitoring.

When a signal is received by the Pager it will vibrate and illuminate either the door or fire symbol. At night when the Pager is docked into the bedside charger a vibrating pillow pad will activate to wake the user.

The SignWave illuminates either the Door or Fire symbol, produces a sound to simulate the event and flashes a high intensity strobe. At night, when docked on its bedside base, a vibrating pillow pad activates to wake the user.

Ideal for housing providers looking for a fixed, dependable solution.



Doorbell

Interconnected smoke alarms



OR

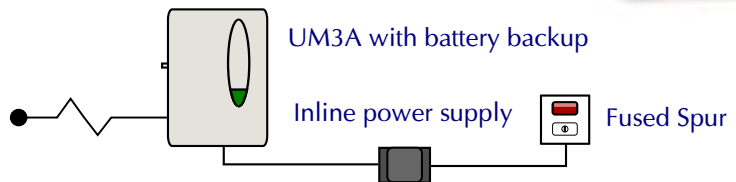
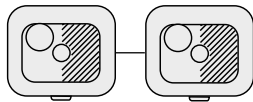

## Operating Range



- 24 Hour Cover
- All component parts are mains powered with monitored backup battery
- Choice of Pager or SignWave receiver
- Deaf blind accessible
- Can link to interconnect carbon monoxide alarms & heat detectors
- Additional alert options include telephone, person to person alert, baby alarm, car and burglar alarm



## Making existing Aico based BS5839-6 domestic smoke, Heat and Carbon Monoxide alarm systems accessible to deaf and hard of hearing people.

The InterLink monitor provides a simple bridge between Aico wireless Smoke, Heat and Carbon Monoxide alarms and the Silent Alert Paging System for deaf people.

The unit links directly to either the Aico Ei413 RadioliNK Panel Interface Module or the Aico Ei414 Fire/ Co Alarm Interface.

The vibrating pager provides a portable alert during the day with night cover provided via a vibrating pillow pad. The SignWave has a two tone audio alarm and bright LED strobe together with a vibrating pillow pad at night.

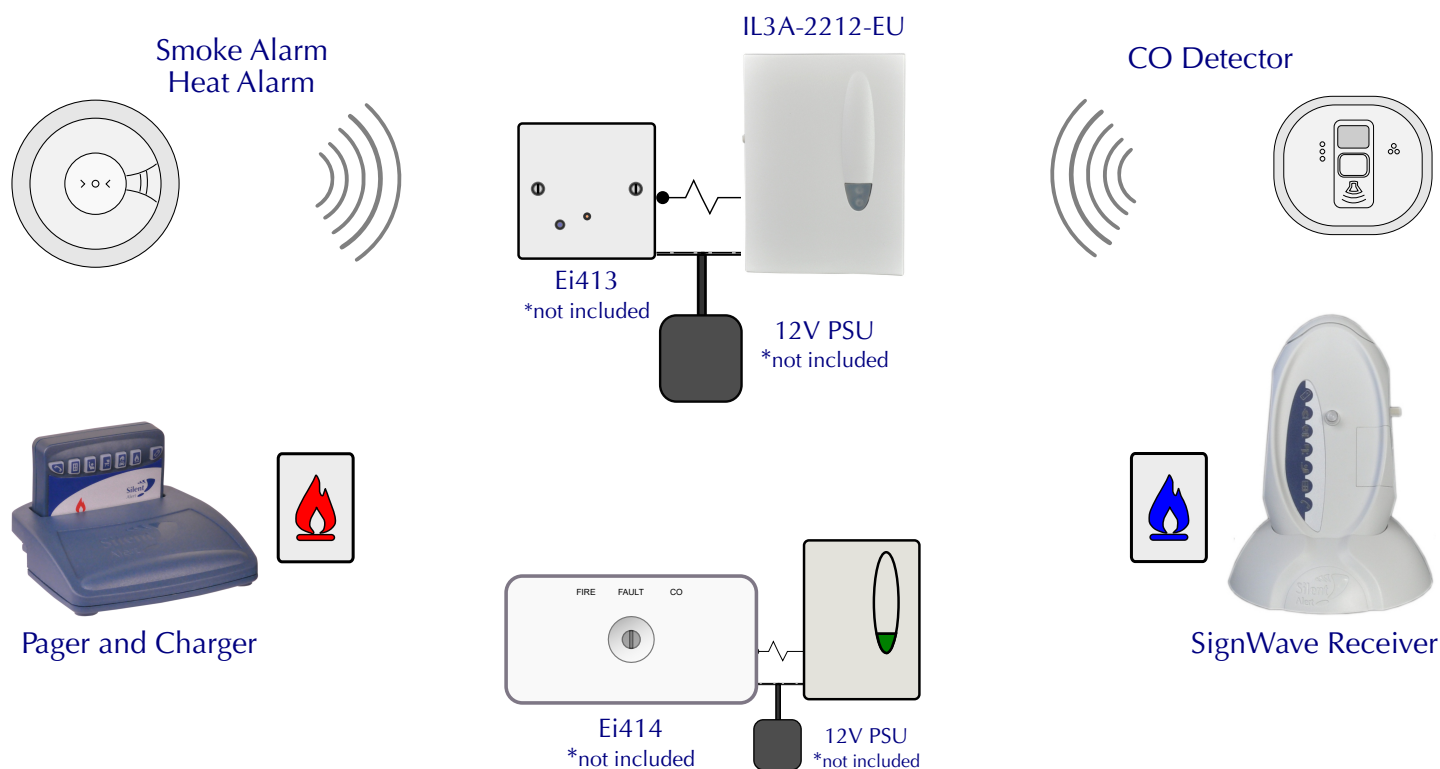

- Differentiates between a Smoke/Heat alarm and Carbon Monoxide alarm activation depending on which of the two relays within the Aico Interfaces switches. A Smoke / Heat alarm causes the flame symbol on the receivers to shine red whilst a Carbon Monoxide causes the same symbol to light blue.
- Vibrating Pager and or SignWave sounder flash unit receiver options with vibrating pillow pad to wake the user at night. Mains failure battery backup ensures that the receivers and pillow pad remain fully functional in the event of a power cut.
- Utilises existing smoke, heat & Carbon Monoxide Alarms. No need to duplicate or replace alarms.
- Mains Powered via a shared 12V DC transformer\* & battery backup with an automatic mains failure alarm sent to the receivers.
- Door, Door Entry and other alert options can be added from the Silent Alert Range.



## Movement Monitor with audio sensing

This compact mains powered wireless Movement Monitor is simple to fit and easy to install. Incorporating an infrared sensor, the monitor will signal the Pager or portable SignWave receiver whenever a person passes through the sensor's field of view.

Ideal for use when caring for someone who may wander or young child, the Monitor can be angled to cover a specific room or staircase, allowing free passage to other rooms without activating the Pager or SignWave receiver.

The Monitor can also be located low down at a bedside to act as a bed leaving alarm, where a pressure pad would not be appropriate.

The Movement Monitor includes an audio sensor with variable sensitivity and time delays for use when monitoring sounds within a room such as a child crying or a person calling for assistance.

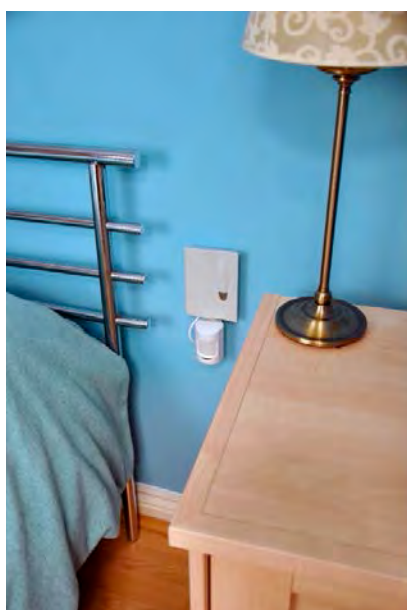

- Simple to install
- Simple screw fixings included
- Audio sensor with volume sensitivity and time delay
- Operating range in open air approximately 1000m
- 1 year warranty
- Technical Helpline
- Adjustable directional movement sensor

### Operating Range

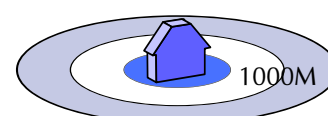

## Mini Monitor with sounder

The Mini Monitor can be used as a wireless stand alone bell push or can replace a bell push on an existing wired door chime. Simply install a 9V PP3 alkaline battery and the unit is ready to go.

The new improved Mini Monitor has an internal sounder. When activated the monitor will chime providing visitors with assurance the button has been pressed.

The Monitor can be setup to inform the user of doorbell, door entry alerts and car / house alarms.

Other specialised alerting applications can also be accommodated. Contact Clofield to discuss your requirements.

The Monitor comes complete with simple screw fixings to allow the unit to be wall or surface mounted and an optional StormGuard can be purchased when the monitor is to be used outside in areas exposed to the weather.



- Can be used to replace an existing bell push
- StormGuard option Auto battery voltage indication
- on startup Can link to door entry, car and burglar alarms.
- Automatic low battery signal to Pager or SignWave
- 1 year warranty
- Technical helpline
- Operating range in open air approximately 1000m



## Mini Telephone Monitor

The Mini Telephone Monitor is easy to fit and enables the user to be alerted to incoming calls to their phone, textphone and fax.

Simply insert a 9 Volt battery into the battery compartment and plug into a telephone socket. When a call is received, the Monitor sends a signal to the Pager or SignWave receiver.

With the new automatic signal cancellation the user only needs to pick up the phone to cancel the SignWave or Pager.

Anti line test software ensures there are no false triggers.

It is possible to be alerted to a second telephone such as a business or fax line. An unused symbol on the receiver can be designated for the second line to enable the user to tell which line is ringing.

A microfilter is required when used with a broadband enabled telephone line.

If mobile phone monitoring is required use a Universal Monitor's audio pickup.



### Operating Range

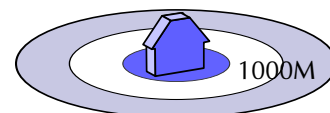

- Automatic signal cancellation
- Small discreet design
- Auto battery voltage indication on startup
- Will not false trigger on line testing
- Automatic low battery signal to Pager or SignWave
- 1 year warranty
- Technical Helpline
- Operating range in open air approximately 1000m



Made in the UK



## Magnetic Door Monitor

This compact battery operated wireless door monitor is simple to fit and discreet.

Powered by a 9V battery, the unit sends a signal to the Pager or portable SignWave each time the magnet is moved away from the Monitor.

The Magnetic Door Monitor is ideal for use when caring for someone who may wander, or in any situation where a person may need to be alerted to the opening of a door or window.

The Monitor will also alert the user when the internal battery needs to be replaced.



- Simple to install
- Battery powered
- Automatic low battery signal to Pager or SignWave
- 1 year warranty
- Technical Helpline
- Simple screw fixings included
- Auto battery voltage indication on startup
- Operating range in open air approximately 1000m

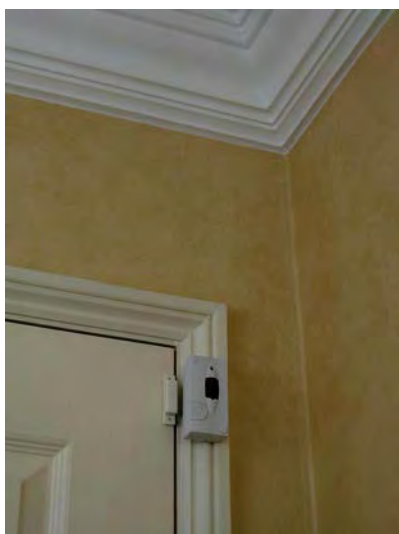

### Operating Range

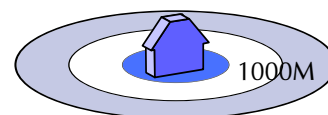

Made in the UK



## Chair Leaving Mini Monitor

### Chair Leaving Pad

This compact, battery operated wireless Chair Leaving Monitor is both simple to fit and discreet in operation. Powered by a 9V alkaline battery, the Monitor sends a signal to a Pager or SignWave portable receiver when a person releases pressure from the chair leaving pad.

The Chair leaving Monitor is ideal for use when caring for someone who may wander or have difficulty when trying to stand.

When a signal is received from the Monitor it will be indicated as a person to person signal on the Receiver.



- Simple to install
- Discreet
- Automatic low battery signal to Pager or SignWave
- 1 year warranty
- Technical Helpline
- Durable and hard wearing pressure pad
- Operating range in open air approximately 1000m



### Operating Range

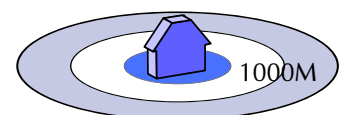



## Mini Monitor with Lead

### Under Carpet Pressure Pad

This compact battery operated wireless Monitor is designed to be used with an under carpet pressure pad. When a person steps onto the pressure pad, the monitor sends a signal to the Pager or portable SignWave.

The Mini Monitor is ideal for use when caring for someone who may wander or need assistance when getting out of bed.

The Monitor is also ideal in any situation where a person may need to be alerted to someone entering or leaving a room either in the home or the workplace.



- Simple to install
- Discreet
- Automatic low battery signal to Pager or SignWave
- 1 year warranty
- Technical Helpline
- Simple screw fixings included
- Auto battery voltage indication on startup
- Operating range in open air approximately 1000m



### Operating Range

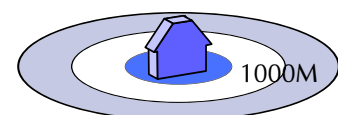

## Emergency Person to Person Key Fob

## Fall Alarm Person to Person Key Fob

The Mini Person to Person Key Fob can be used to page a carer in another part of the home or workplace. Ideal when caring for someone who is either ill, has mobility problems or is prone to falling.

Powered by a 6V Lithium battery, the Key Fob sends a signal to a Pager or SignWave portable receiver. The Key Fob will also signal to the receiver when the battery needs changing.



- Simple to use
- Neck cord incorporating a safety break
- Automatic low battery signal to Pager or SignWave
- Shock detector option to alert a carer to a fall
- 1 year warranty
- Technical Helpline
- Operating range in open air approximately 1000m



### Operating Range

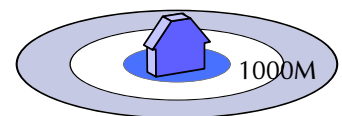

## Fire Safe Interface

The Fire Safe Interface provides early warning of fire to Deaf and hearing people, who live, work or socialise in buildings where a commercial type BS: 5839-1 fire warning system is installed

The Fire Safe panel is designed to comply with all relevant parts of BS:5839-1 2013 & EN BS54-25, and links to the buildings existing fire alarm main panel via a volt free relay. The integral radio transmitter gives a range of up to 1000 metres in open air, with good coverage in most types of building structure.

By simply linking the Fire Safe Interface Panel into the existing fire warning system, Deaf and Hard of Hearing people are automatically alerted via their personal Pager or SignWave portable receiver.



Fire Safe users are able to receive information from other monitors in the Silent Alert range, such as doorbell, telephone, baby alarm and door entry phones.

Fire Safe offers building managers and alarm installers a simple, inexpensive and effective system that is easy to install and cheap to maintain. The equipment can be fitted and maintained by the customer's own fire alarm maintenance company and is free from high cost long term maintenance contracts.



- Compliant with BS: 5839-1 2013 & EN BS54-25
- Mains powered with battery backup
- Suitable for all types of fire warning systems
- Low cost installation and maintenance
- Radio licence exempt
- Signal override broadcast to alert multiple receivers
- Positive confirmation of logon when entering building
- Logoff reminder when leaving building area.
- Fully compatible with Silent Alert home paging systems
- 1 year warranty
- Technical Helpline
- Operating range in open air approximately 1000m



## Mini Monitor    Universal Monitor

Silent Alert monitors have been adapted for use with specific third party products to enable the Deaf or Hard of Hearing user to be alerted to activation of equipment or events that they otherwise would not have access to.

Monitors are designed to interface with an extensive range of equipment by the addition of bespoke connectors and software programmes that will enable an alert to be sent to a Pager or SignWave portable receiver



The Monitors can be setup to inform the user of events such as the activation of an epilepsy monitor, bed occupancy monitor and neonatal respiration monitor alarms. Many specialised alerting applications can be accommodated, either in the home, at work or in the professional & domestic care environment. Contact us to discuss your requirements.

- Epilepsy alarms
- Bed occupancy alarms
- Respiratory equipment alarms
- Enuresis alarms



- Automatic low battery signal to Pager or SignWave
- 1 year warranty
- Technical Helpline
- Operating range in open air approximately 1000m





## DDA Kits to link with Telecare Systems



The DDA Kits simply connect to Telecare Communicators, which can be programmed to trigger the Pager or SignWave when an integrated smoke alarm is activated.

The Pager Kit, designed for profoundly deaf users and the SignWave kit, for hard of hearing users, both incorporate a vibrating pillow pad to wake the user at night.

Compatible with all leading telecare systems.

- Simple to fit
- Compatible with all leading telecare systems
- Competitively priced
- Fire Safe compatible, can alert user when main building fire alarm activates
- Additional alerts can be added from the SA3000 System
- 1 year warranty
- Technical helpline

### DDA SignWave Kit for Hard of Hearing people

Systems from just **£176.16\*** includes SignWave, Pillow Pad and Mini Monitor



### DDA Pager Kit for profoundly Deaf people

Systems from just **£199.99\*** includes Pager, Trickle Charger, Pillow Pad and Mini Monitor

\*Price EX VAT + P&P



Made in the UK

